

TeSys GV4PEM / GV4PB

Motor Protection Devices

User Guide

09/2019



DOCA0118EN-01

www.schneider-electric.com

Schneider
Electric



RSPSupply - 1-888-532-2706 - <https://www.RSPSupply.com>
See the product details here

The information provided in this documentation contains general descriptions and/or technical characteristics of the performance of the products contained herein. This documentation is not intended as a substitute for and is not to be used for determining suitability or reliability of these products for specific user applications. It is the duty of any such user or integrator to perform the appropriate and complete risk analysis, evaluation and testing of the products with respect to the relevant specific application or use thereof. Neither Schneider Electric nor any of its affiliates or subsidiaries shall be responsible or liable for misuse of the information contained herein. If you have any suggestions for improvements or amendments or have found errors in this publication, please notify us.

You agree not to reproduce, other than for your own personal, noncommercial use, all or part of this document on any medium whatsoever without permission of Schneider Electric, given in writing. You also agree not to establish any hypertext links to this document or its content. Schneider Electric does not grant any right or license for the personal and noncommercial use of the document or its content, except for a non-exclusive license to consult it on an "as is" basis, at your own risk. All other rights are reserved.

All pertinent state, regional, and local safety regulations must be observed when installing and using this product. For reasons of safety and to help ensure compliance with documented system data, only the manufacturer should perform repairs to components.

When devices are used for applications with technical safety requirements, the relevant instructions must be followed.

Failure to use Schneider Electric software or approved software with our hardware products may result in injury, harm, or improper operating results.

Failure to observe this information can result in injury or equipment damage.

© 2019 Schneider Electric. All rights reserved.

Table of Contents



	Safety Information	5
	About the Book	7
Chapter 1	Introduction	9
	TeSys GV4PEM / GV4PB Devices	10
	Device Overview	11
	EcoStruxure Power Commission Software	14
	EcoStruxure Power Device App	15
Chapter 2	Protection Functions	17
2.1	Introduction	18
	Protection for Motor-Feeders	19
	Motor Operating States	20
	Trip Unit Description	21
2.2	Basic Protections	24
	Overload or Thermal Protection (ANSI 49) for TeSys GV4PEM Devices	25
	Overload or Thermal Protection (ANSI 49) for TeSys GV4PB Devices	27
	Short-Circuit Protection (ANSI 50)	30
2.3	Advanced Protections	31
	Short-Time Delay Protection (ANSI 51)	32
	Ground-Fault Protection (ANSI 51N)	33
	Phase Unbalance Protection (ANSI 46)	34
	Motor Jam Protection (ANSI 48/51LR)	37
	Long-Start Motor Protection (ANSI 48/51LR)	39
Chapter 3	Event History	41
	Event History	41
Chapter 4	Electrical Auxiliary Devices	43
	Electrical Auxiliary Devices	44
	Indication Contacts	45
	Voltage Releases	47
	SDx Module	48
Chapter 5	Settings	55
	Settings With the EcoStruxure Power Commission Software	56
	Settings With the EcoStruxure Power Device App	58



Safety Information



Important Information

NOTICE

Read these instructions carefully, and look at the equipment to become familiar with the device before trying to install, operate, service, or maintain it. The following special messages may appear throughout this documentation or on the equipment to warn of potential hazards or to call attention to information that clarifies or simplifies a procedure.



The addition of this symbol to a “Danger” or “Warning” safety label indicates that an electrical hazard exists which will result in personal injury if the instructions are not followed.



This is the safety alert symbol. It is used to alert you to potential personal injury hazards. Obey all safety messages that follow this symbol to avoid possible injury or death.

DANGER

DANGER indicates a hazardous situation which, if not avoided, **will result in** death or serious injury.

WARNING

WARNING indicates a hazardous situation which, if not avoided, **could result in** death or serious injury.

CAUTION

CAUTION indicates a hazardous situation which, if not avoided, **could result in** minor or moderate injury.

NOTICE

NOTICE is used to address practices not related to physical injury.

PLEASE NOTE

Electrical equipment should be installed, operated, serviced, and maintained only by qualified personnel. No responsibility is assumed by Schneider Electric for any consequences arising out of the use of this material.

A qualified person is one who has skills and knowledge related to the construction and operation of electrical equipment and its installation, and has received safety training to recognize and avoid the hazards involved.

SAFETY NOTICE

  DANGER

HAZARD OF ELECTRIC SHOCK, EXPLOSION, OR ARC FLASH

- Apply appropriate personal protective equipment (PPE) and follow safe electrical work practices. See NFPA 70E, CSA Z462, NOM 029-STPS or local equivalent.
- This equipment must only be installed and serviced by qualified electrical personnel.
- Turn off all power supplying this equipment before working on or inside this equipment.
- Always use a properly rated voltage sensing device to confirm power is off.
- Replace all devices, doors, and covers before turning on power to this equipment.
- Beware of potential hazards, and carefully inspect the work area for tools and objects that may have been left inside the equipment.

Failure to follow these instructions will result in death or serious injury.

About the Book



At a Glance

Document Scope

This guide provides users, installers, and maintenance personnel with technical information needed to operate:

- TeSys™ GV4PEM devices in compliance with IEC/EN and UL/CSA standards:
 - In IEC/EN standards, TeSys GV4PEM devices are motor circuit breakers.
 - In UL/CSA standards, TeSys GV4PEM devices are manual motor protectors.
- TeSys™ GV4PB motor protection circuit breakers in compliance with the UL489 standard.

In this guide, the term *device* covers:

- Motor circuit breakers
- Manual motor protectors
- Motor protection circuit breakers

Validity Note

This document applies to TeSys GV4PEM devices and TeSys GV4PB devices.

Online Information

The information contained in this guide is likely to be updated at any time. Schneider Electric strongly recommends that you have the most recent and up-to-date version available on www.schneider-electric.com.

The technical characteristics of the devices described in the present document also appear online. To access the information online:

Step	Action
1	Go to the Schneider Electric home page www.schneider-electric.com .
2	In the Search box type the reference of a product or the name of a product range. <ul style="list-style-type: none">● Do not include blank spaces in the reference or product range.● To get information on grouping similar modules, use asterisks (*).
3	If you entered a reference, go to the Product Datasheets search results and click on the reference that interests you. If you entered the name of a product range, go to the Product Ranges search results and click on the product range that interests you.
4	If more than one reference appears in the Products search results, click on the reference that interests you.
5	Depending on the size of your screen, you may need to scroll down to see the datasheet.
6	To save or print a datasheet as a .pdf file, click Download XXX product datasheet .

The characteristics that are presented in the present document should be the same as those characteristics that appear online. In line with our policy of constant improvement, we may revise content over time to improve clarity and accuracy. If you see a difference between the document and online information, use the online information as your reference.

Related Documents

Title of Documentation	Reference Number
<i>TeSys Catalogue</i>	MKTED210011EN
<i>TeSys GV4PEM / GV4PB Devices - Instruction Sheet</i>	EAV91201
<i>TeSys GV4PEM / GV4PB - SDx Module - Instruction Sheet</i>	EAV91207

You can download these technical publications and other technical information from our website at www.schneider-electric.com.

Trademark Notice

All trademarks are owned by Schneider Electric Industries SAS or its affiliated companies.

Chapter 1

Introduction

What Is in This Chapter?

This chapter contains the following topics:

Topic	Page
TeSys GV4PEM / GV4PB Devices	10
Device Overview	11
EcoStruxure Power Commission Software	14
EcoStruxure Power Device App	15

TeSys GV4PEM / GV4PB Devices

TeSys GV4PEM Device Overview

TeSys GV4PEM devices offer current ratings from 2 to 115 A, for AC power systems up to 690 Vac (IEC standard).

TeSys GV4PEM devices have the following features:

- 3-pole devices
- 10E and 20E trip classes
- The following accessories are optional and installable on site:
 - Terminations
 - Operating mechanisms
 - Voltage releases
 - Auxiliary contacts
 - Insulation accessories
 - Locking accessories
- Breaking capacities:
 - 25, 50, 100 kA at 415 Vac (IEC standard)
 - 18, 35, 65 kA at 480 Vac (UL standard)
- Compliance to:
 - IEC/EN 60947-2 standard
 - IEC/EN 60947-4-1 standard
 - UL/CSA 60947-4-1 standard

TeSys GV4PB Device Overview

TeSys GV4PB devices offer current ratings from 2 to 115 A, for AC power systems up to 600 Y/347 V.

TeSys GV4PB devices have the following features:

- 3-pole devices
- 10 and 20 trip classes
- The following accessories are optional and installable on site:
 - Terminations
 - Operating mechanisms
 - Voltage releases
 - Auxiliary contacts
 - Insulation accessories
 - Locking accessories
- Breaking capacities: 18, 35, 65 kA at 480 Y/277 V
- Compliance to:
 - UL 489 and CSA-C22.2 No. 5 standards, with their supplements SH and SE
 - IEC/EN 60947-4-1 standard

Device Overview

Device Description

TeSys GV4PEM device

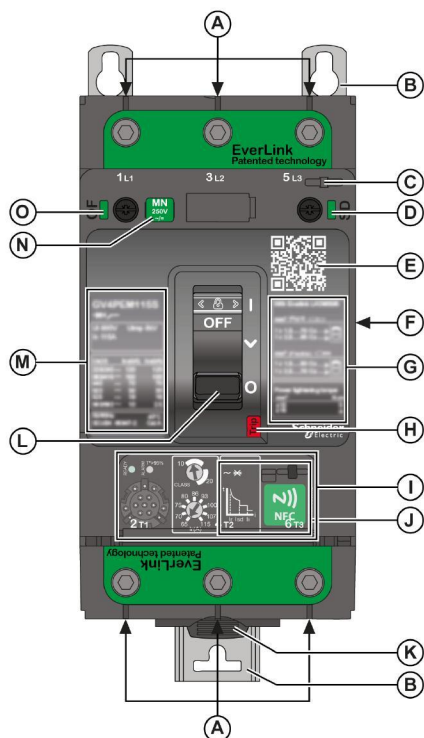

TeSys GV4PB device

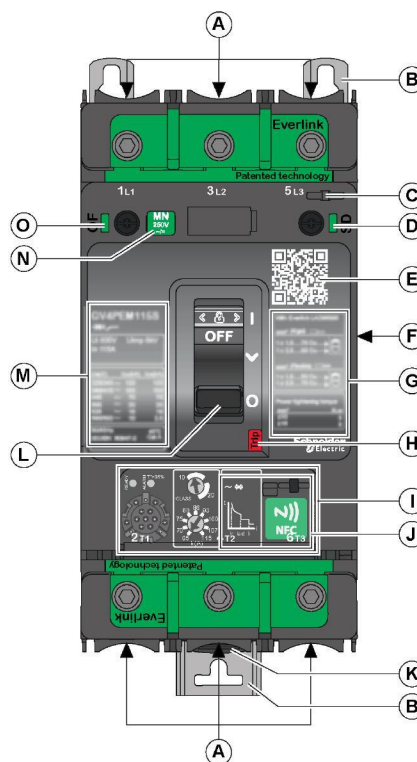

- | | | | |
|---|--|---|---|
| A | Power connection (EverLink™ lug, compression lug / busbar) | I | Trip unit (<i>see page 21</i>) |
| B | Panel mounting feet | J | NFC wireless communication zone |
| C | Seal for cover | K | DIN rail lock |
| D | SD presence indicator | L | Toggle handle |
| E | QR code to device information | M | Device identification, certification marks, and IEC/EN interrupting ratings |
| F | Device and accessory data labels | N | MN or MX presence indicator |
| G | Termination information | O | OF presence indicator |
| H | Push-to-trip button | | |

QR Code

Scan the QR code to get additional information about the device from the Schneider Electric website. To scan the QR code, use a smartphone that is equipped with a camera and installed with a QR code reader.

Accessories

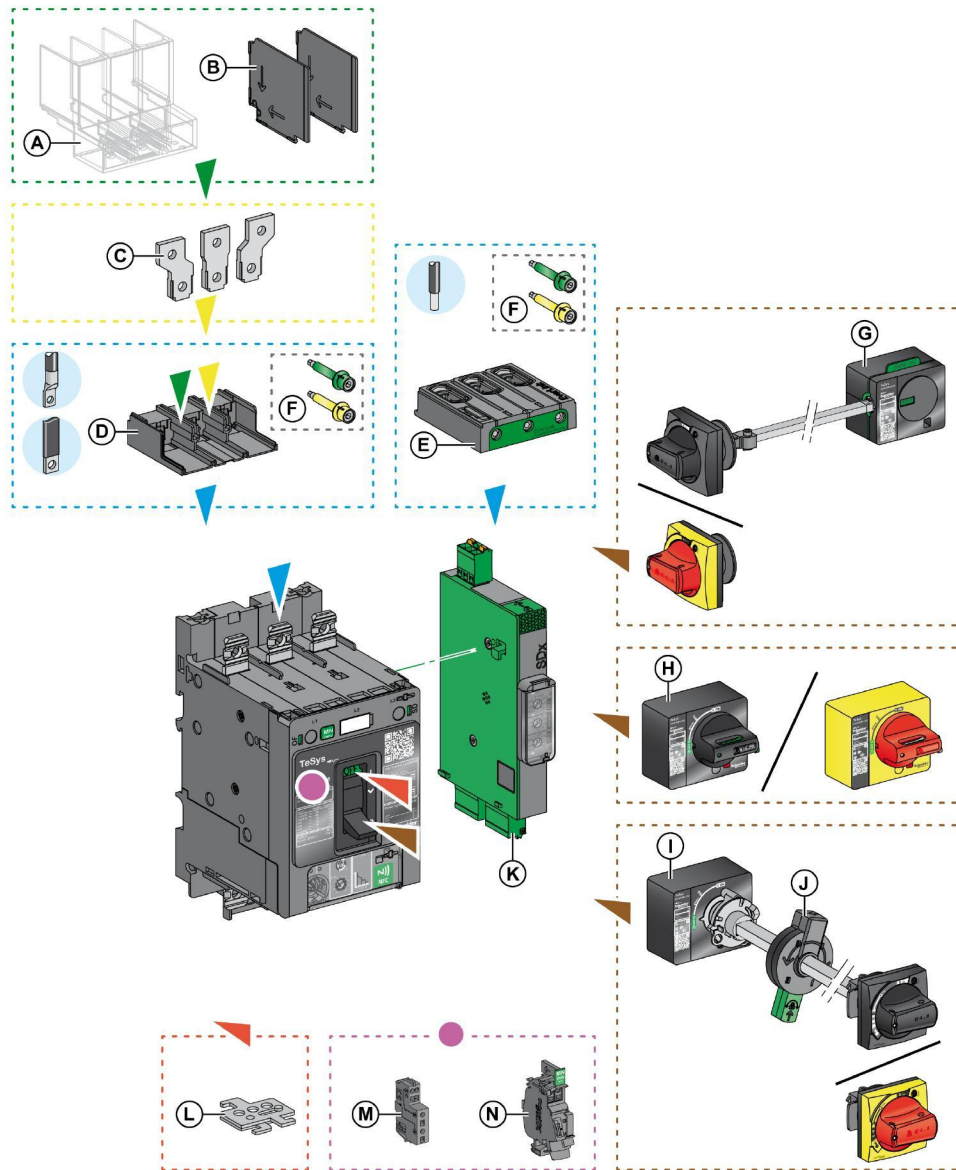

- | | | | |
|---|--------------------------------|---|--|
| A | Long terminal shield | H | Direct mounted rotary handle |
| B | Interphase barriers | I | Extended rotary handle |
| C | Terminal spreaders | J | Open door shaft operator |
| D | Crimp lug/busbar connector | K | SDx module (<i>see page 48</i>) |
| E | EverLink connector | L | Removable toggle handle padlocking device (OFF only) |
| F | Torque limiting breakaway bits | M | OF or SD auxiliary contact |
| G | Side rotary handle | N | MN or MX voltage release |

Sealing Accessories

The following sealing accessories can help prevent unauthorized changes to the device.

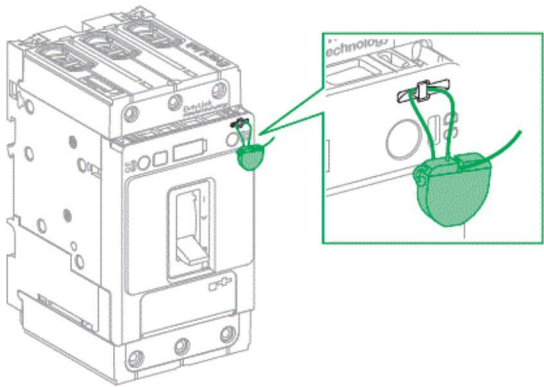
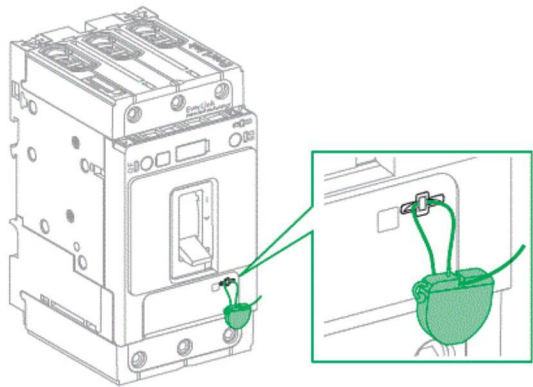
Seal type	Helps to prevent	Seal image
Seal for cover	<ul style="list-style-type: none"> • Opening of the front cover • Access to the auxiliaries 	
Seal for settings	<ul style="list-style-type: none"> • Access to the adjustment dials (trip class and Ir) <p>NOTE: Advanced protection functions can be set through NFC communication, with the setting cover sealed</p> <ul style="list-style-type: none"> • Access to the maintenance port 	

EcoStruxure Power Commission Software

Overview

EcoStruxure™ Power Commission is the new name of Ecoeach software.

EcoStruxure Power Commission software helps you to manage a project as part of testing, commissioning, and maintenance phases of the project life cycle. The innovative features in it provide simple ways to configure, test, and commission the smart electrical devices.

EcoStruxure Power Commission software automatically discovers the smart devices and allows you to add the devices for an easy configuration. Additionally, when the panels are under operation, any change of settings made can be easily identified and hence provides a system consistency during the operation and maintenance phase.

EcoStruxure Power Commission software enables the configuration of TeSys GV4PEM / GV4PB devices.

For more information, refer to *EcoStruxure Power Commission Online Help*.

The EcoStruxure Power Commission software is available at www.schneider-electric.com.

Key Features

The EcoStruxure Power Commission software performs the following actions for the supported devices and modules:

- Create projects by device discovery.
- Save EcoStruxure Power Commission projects in EcoStruxure Power Commission cloud repository.
- Upload settings to the device and download settings from the device.
- Compare the settings between the project and the device.
- Generate and print the device settings report.

EcoStruxure Power Commission Software and TeSys GV4PEM / GV4PB Devices

Use the EcoStruxure Power Commission software to access the following information:

- Information about the devices
- Display of the protection settings
- Setting of the advanced protection functions

For information about the use of the software, refer to the Settings chapter (*see page 55*).

EcoStruxure Power Device App

Introduction

EcoStruxure™ Power Device app is a single mobile application with the necessary information and capabilities to operate and efficiently maintain devices in the EcoStruxure architecture.

The application enables you to connect to Schneider Electric devices, including:

- TeSys GV4PEM / GV4PB motor circuit breakers
- MasterPact MTZ circuit breakers
- Easergy P3 protection relays

Downloading the Application

The EcoStruxure Power Device app can be downloaded as follows:

- By scanning the QR code on the front face of TeSys GV4PEM / GV4PB devices to access the product related webpage. Click the link to go to Google Play Store from which the EcoStruxure Power Device app can be downloaded.
- From Google Play Store for Android smartphones.

The EcoStruxure Power Device app is optimized for a 127 mm (5 in) display screen.

Using the Application

Connecting to the EcoStruxure Power Device app with an NFC connection allows you to:

- Read information about the device.
- Read and change the advanced protection settings.
- Save the advanced protection settings and write them to the device.
- Manage the trip and alarm history.

For information about the use of the app, refer to the Settings chapter (*see page 58*).

Chapter 2

Protection Functions

What Is in This Chapter?

This chapter contains the following sections:

Section	Topic	Page
2.1	Introduction	18
2.2	Basic Protections	24
2.3	Advanced Protections	31

Section 2.1

Introduction

What Is in This Section?

This section contains the following topics:

Topic	Page
Protection for Motor-Feeders	19
Motor Operating States	20
Trip Unit Description	21

Protection for Motor-Feeders

Description

TeSys GV4PEM / GV4PB devices:

- Provide protections for direct-on-line motor-feeders and star-delta motor starters (direct-on-line starting is the most widely used type of motor-feeder).
- Integrate the basic protections (overload or short-circuit) for the motor-feeder and additional advanced protections for motor applications.
- Allow protection and coordination of the motor-feeder components that comply with the requirements of IEC/EN 60947-2 and IEC/EN 60947-4-1 standards.
- Can be used to create motor-feeders with two devices.

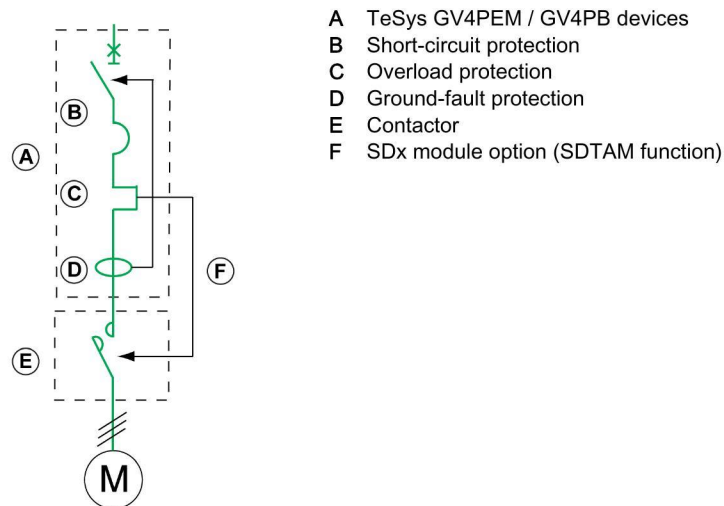

Motor Operating States

Introduction

TeSys GV4PEM / GV4PB devices consider the application to be operating as soon as the 10% of I_r pickup is crossed in a positive direction by the motor current.

Two operating states are considered:

- Startup state
- Steady state

Startup State

The application is considered to be in startup state according to the following criteria:

- Start: As soon as the 10% of I_r pickup is crossed in a positive direction by the motor current.
- End: As soon as the I_d pickup is crossed in a negative direction or at maximum after a t_d time delay defined as follows:
 - If long-start protection has not been activated (default setting), the I_d pickup equals $1.5 \times I_r$ and the t_d time delay equals 10 s (non-adjustable parameters). Exceeding the 10 s time delay does not result in tripping.
 - If long-start protection has been activated, the I_d pickup equals I_{long} and the t_d time delay equals t_{long} (adjustable parameters). Exceeding the t_{long} time delay results in long-start protection tripping.

NOTE: The trip unit filters the subtransient state (first current peak of approximately 20 ms on contactor closing). This current peak is not therefore taken into account when assessing whether the I_d pickup has been crossed.

Steady State

The application is considered to be in steady state according to the following criteria:

- Start: As soon as startup ends.
- End: As soon as the 10% of I_r pickup is crossed in a negative direction by the motor current.

Operating Diagram

The following diagrams show the two cases of transition between startup and steady state:

Operating states with current $I < I_d$ before end of t_d

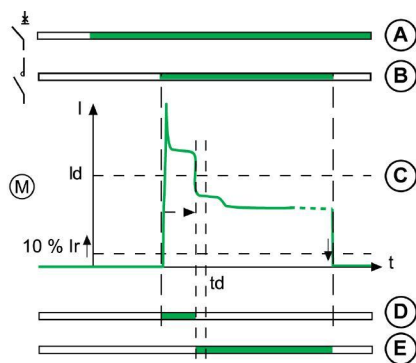

Operating states with current $I > I_d$ at end of t_d

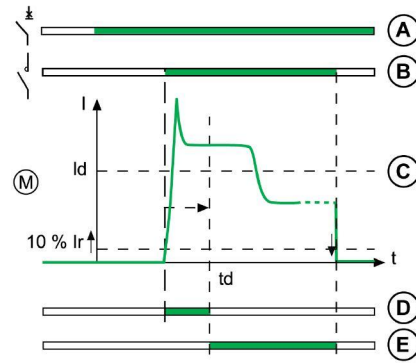

- A TeSys GV4PEM / GV4PB device status (green: ON position)
- B Contactor status (green: ON position)
- C Current in the motor
- D Operating state: startup state (green: active state)
- E Operating state: steady state (green: active state)

Trip Unit Description

Introduction

The trip unit is suitable for protecting motor-feeders on standard applications. The thermal trip curves are calculated for self-ventilated motors.

Description

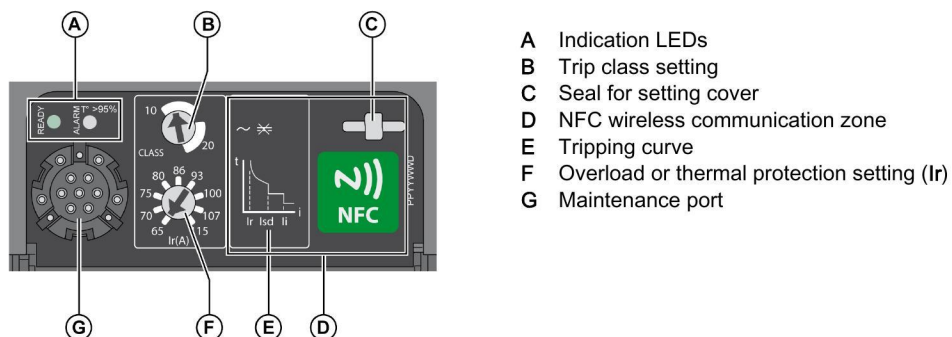

- A Indication LEDs
- B Trip class setting
- C Seal for setting cover
- D NFC wireless communication zone
- E Tripping curve
- F Overload or thermal protection setting (I_r)
- G Maintenance port

Indication LEDs



Indication LEDs on the front of the trip unit indicate its operational state.

Indication LED	Description
Green READY LED	Flashes slowly when the trip unit is ready to trip.
Red ALARM LED	Shows a steady light when the thermal image of the motor is greater than 95% of the permissible temperature rise.

The LED on the front of the trip unit indicates the result of the self-test, which runs continuously on the measurement system and the tripping release.

As long as the green LED is flashing, the links between the current transformers, the processing electronics, and the Mitop release are operational. The device is functioning correctly. A minimum current of 15 to 50 A, depending on the device, is required for this indication function.

Protection Functions

The following figure and table define the protection functions performed by the trip unit:

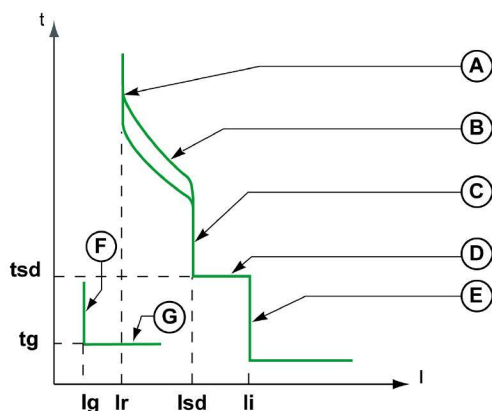

Item	Parameter	Description	Adjustable	Default activation	Default setting	SDTAM activation
A	I _r	Overload or thermal protection pickup	Yes ⁽¹⁾	Always ON	0.4 x I _n	Yes
B	Class	Trip class	Yes ⁽¹⁾	Always ON	10	Yes
C	I _{sd}	Short-time delay protection pickup	Yes ⁽²⁾	Always ON	13 x I _r	No
D	t _{sd}	Short-time delay protection time delay	No	Always ON	0.1 s	No
E	I _i	Short-circuit protection pickup	No	Always ON	17 x I _n	No
F	I _g	Ground-fault protection pickup	Yes ⁽²⁾	ON	1 x I _n	No
G	t _g	Ground-fault protection time delay	Yes ⁽²⁾	ON	0.1 s	No
-	I _{unbal}	Phase unbalance protection pickup	Yes ⁽²⁾	Always ON	30%	Yes
-	t _{unbal}	Phase unbalance protection time delay during startup	No	Always ON	0.7 s	Yes
-		Phase unbalance protection time delay in steady state	Yes ⁽²⁾	Always ON	4 s	Yes
-	I _{jam}	Motor jam protection pickup	Yes ⁽²⁾	OFF	2 x I _r	Yes
-	t _{jam}	Motor jam protection time delay	Yes ⁽²⁾	OFF	5 s	Yes
-	I _{long}	Long-start motor protection pickup	Yes ⁽²⁾	OFF	1.5 x I _r	No
-	t _{long}	Long-start motor protection time delay	Yes ⁽²⁾	OFF	10 s	No

(1) Parameter adjustable on the trip unit with rotary dials.

(2) Parameter adjustable:

- With the EcoStruxure Power Device app.
- With the EcoStruxure Power Commission software.

Each function is reviewed in detail on the following pages.

Setting the Protection

Set the overload or thermal protection pickup (I_r) and trip class (Class) by using the dials on the device.

Set the other protections:

- With the EcoStruxure Power Device app (*see page 58*).
- With the EcoStruxure Power Commission software (*see page 56*).

Reflex Tripping

The system of reflex protection breaks very high fault currents by mechanically tripping the device with a piston actuated directly by the pressure produced in the device from a short-circuit. This piston operates the opening mechanism, resulting in ultra-fast device tripping.

Section 2.2

Basic Protections

What Is in This Section?

This section contains the following topics:

Topic	Page
Overload or Thermal Protection (ANSI 49) for TeSys GV4PEM Devices	25
Overload or Thermal Protection (ANSI 49) for TeSys GV4PB Devices	27
Short-Circuit Protection (ANSI 50)	30

Overload or Thermal Protection (ANSI 49) for TeSys GV4PEM Devices

Introduction

Overload or thermal protection protects all types of motor applications against overload currents in compliance with IEC/EN/UL 60947-4-1 standard.

Operating Principle

Overload or thermal protection is I^2t IDMT (Inverse Definite Minimum Time):

- It incorporates the motor thermal image function.
- It can be configured as the I_r pickup and as the trip class (Class).

TeSys GV4PEM tripping curve:

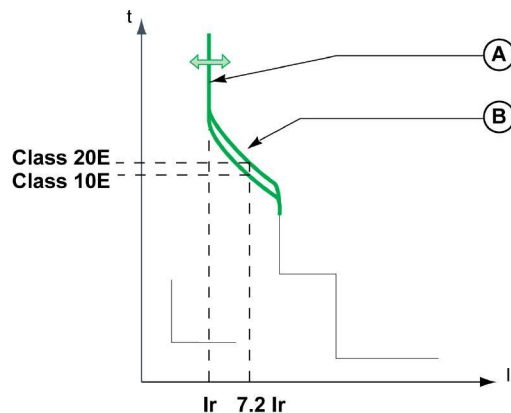

Item	Parameter	Description
A	I_r	Overload or thermal protection pickup.
B	Class	Overload or thermal protection trip class.

NOTE: In presence of an overload, the optional SDx module (*see page 48*) can be used to perform the SDTAM function and command contactor opening instead of device tripping.

I_r Pickup Setting Value

The overload or thermal protection pickup (I_r) is set by using a multi-position dial.

The default I_r pickup setting value is $0.4 \times I_n$ (minimum dial value).

The overload or thermal protection tripping range is $1.05\text{--}1.20 \times I_r$ according to IEC/EN/UL 60947-4-1 standard.

The following table shows the preset values of the adjustment dial I_r in amperes for each current rating I_n :

$I_n = 2\text{ A}$	$I_n = 3.5\text{ A}$	$I_n = 7\text{ A}$	$I_n = 12.5\text{ A}$	$I_n = 25\text{ A}$	$I_n = 50\text{ A}$	$I_n = 80\text{ A}$	$I_n = 115\text{ A}$
0.8	1.4	2.9	5.0	10	20	40	65
0.9	1.6	3.2	5.6	11	22	44	70
1.0	1.8	3.5	6.3	12	25	48	75
1.1	2.0	3.9	7.0	14	28	52	80
1.2	2.3	4.4	8.0	16	32	57	86
1.4	2.6	5.0	9.0	18	36	62	93
1.6	2.9	5.6	10	20	40	67	100
1.8	3.2	6.3	11	22	45	73	107
2.0	3.5	7.0	12.5	25	50	80	115

Trip Class Setting Value

The trip class (Class) is set by using an adjustment dial:

- Class 10E (default value)
- Class 20E

The trip class corresponds to the value of the tripping time delay for a current of $7.2 \times I_r$ according to IEC/EN/UL 60947-4-1 standard.

Motor Thermal Image

The model representing heat rise and cooling in a motor load is constructed according to the algorithm for calculating the thermal demand, taking account of the iron and copper losses.

The following figure represents the limit curves for the iron and copper components calculated for class 20E:

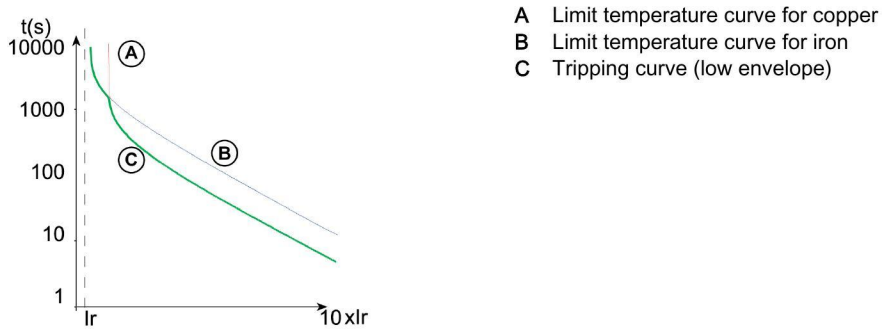

Thermal Memory

The overload or thermal protection includes a thermal memory. The thermal memory helps to protect the motor from overheating in case of low amplitude repetitive overloads.

Electronic thermal protection without thermal memory does not protect against repetitive overloads because the duration of each overload above the pickup setting is too short to cause tripping.

However, each overload causes a temperature rise in the installation. The cumulative effect of successive overloads can overheat the system.

The thermal memory remembers and integrates the thermal heating caused by each pickup setting overrun.

The thermal memory remembers the thermal heating values for 20 minutes before or after tripping.

Example: Comparison of the heat rise calculation without thermal image (diagram A) and with thermal image (diagram B):

Diagram A

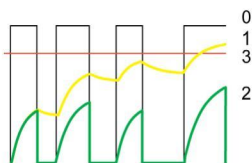
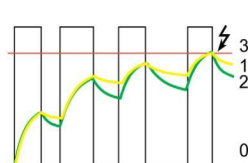

Diagram B



- 0 Load control (cyclical)
- 1 Motor temperature
- 2 Thermal level calculated without thermal image (diagram A), with thermal image (diagram B)
- 3 Overload or thermal protection level

With thermal image, the trip unit adds the thermal effect of successive current pulses. Tripping occurs based on the actual thermal state of the motor.

Cooling Fan

The thermal image of the motor is calculated taking account of the fact that the motor is self-cooled (fan mounted on the shaft end).

Overload or Thermal Protection (ANSI 49) for TeSys GV4PB Devices

Introduction

Overload or thermal protection protects all types of motor applications against overload currents in compliance with:

- UL489 and CSA-C22.2 No.5 standards with their supplement SH
- IEC/EN 60947-4-1 standard

Operating Principle

Overload or thermal protection is I^2t IDMT (Inverse Definite Minimum Time):

- It incorporates the motor thermal image function.
- It can be configured as the I_r pickup and as the trip class (Class).

NOTE: The I_r pickup is also called Full Load Amps or FLA.

TeSys GV4PB tripping curve:

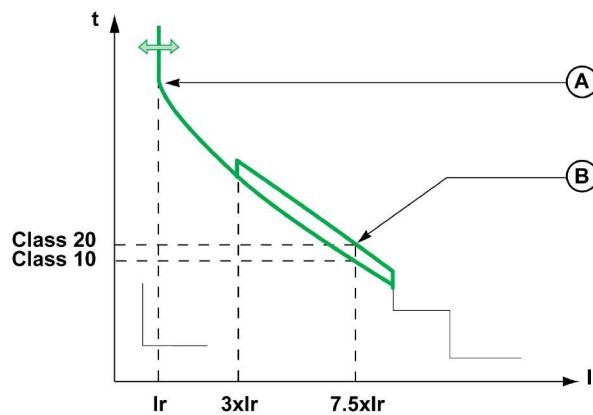

Item	Parameter	Description
A	I_r	Overload or thermal protection pickup
B	Class	Overload or thermal protection trip class

NOTE: In presence of an overload, the optional SDx module (*see page 48*) can be used to perform the SDTAM function and command contactor opening instead of device tripping.

Ir Pickup Setting Value

The overload or thermal protection pickup (Ir) is set by using a multi-position dial.

The default Ir pickup setting value is $0.4 \times I_n$ (minimum dial value).

The rated trip current of TeSys GV4PB devices corresponds to 125% of the Ir adjustment dial. The following table shows the possible positions of the adjustment dial to set the trip current to 115% of Ir, depending on the motor full load current.

Motor full load current (A)	Device rating	Ir adjustment dial position for 125% trip (A)	Ir adjustment dial position for 115% trip (A)
0.8	GV4PB02•	0.8	Use a TeSys GV3P• device
0.9	GV4PB02•	0.9	0.8
1	GV4PB02•	1	0.9
1.1	GV4PB02•	1.1	1
1.2	GV4PB02•	1.2	1.1
1.4	GV4PB02•	1.4	1.2–1.4
1.6	GV4PB02• or GV4PB03•	1.6	1.4–1.6
1.8	GV4PB02• or GV4PB03•	1.8	1.6–1.8
2	GV4PB02• or GV4PB03•	2	1.8
2.3	GV4PB03•	2.3	2
2.6	GV4PB03•	2.6	2.3
2.9	GV4PB03•	2.9	2.6–2.9
3.2	GV4PB03• or GV4PB07•	3.2	2.9
3.5	GV4PB03• or GV4PB07•	3.5	3.2
3.9	GV4PB07•	3.9	3.5
4.4	GV4PB07•	4.4	3.9
5	GV4PB07•	5	4.4
5.6	GV4PB07• or GV4PB12•	5.6	5
6.3	GV4PB07• or GV4PB12•	6.3	5.6
7	GV4PB07• or GV4PB12•	7	6.3
8	GV4PB12•	8	7–8
9	GV4PB12•	9	8
10	GV4PB12•	10	9
11	GV4PB12• or GV4PB25•	11	10
12.5	GV4PB12• or GV4PB25•	12.5	11–12.5
14	GV4PB25•	14	12–14
16	GV4PB25•	16	14–16
18	GV4PB25•	18	16–18
20	GV4PB25•	20	18
22	GV4PB25• or GV4PB50•	22	20
25	GV4PB25• or GV4PB50•	25	22
28	GV4PB50•	28	25
32	GV4PB50•	32	28
36	GV4PB50•	36	32
40	GV4PB50•	40	36
44/45	GV4PB50• or GV4PB80•	44/45	40
48	GV4PB80•	48	44
50	GV4PB50• or GV4PB80•	50	45
52	GV4PB80•	52	48
57	GV4PB80•	57	52
62	GV4PB80•	62	57
67	GV4PB80•	67	62
73	GV4PB80•	73	67

Motor full load current (A)	Device rating	Ir adjustment dial position for 125% trip (A)	Ir adjustment dial position for 115% trip (A)
75	GV4PB115•	75	70
80	GV4PB80• or GV4PB115•	80	73–75
86	GV4PB115•	86	80
93	GV4PB115•	93	86
100	GV4PB115•	100	93
107	GV4PB115•	107	100
115	GV4PB115•	115	107

Trip Class Setting Value

The trip class (Class) is set by using an adjustment dial:

- Class 10 (default value)
- Class 20

The trip class corresponds to the value of the tripping time delay for a current of 600% of the rated tripping current, according to UL489 and CSA-C22.2 No.5 standards with their supplement SH.

Motor Thermal Image

The model representing heat rise and cooling in a motor load is constructed according to the algorithm for calculating the thermal demand, taking account of the iron and copper losses.

Thermal Memory

The overload or thermal protection includes a thermal memory. The thermal memory helps to protect the motor from overheating in case of low amplitude repetitive overloads.

Electronic thermal protection without thermal memory does not protect against repetitive overloads because the duration of each overload above the pickup setting is too short to cause tripping.

However, each overload causes a temperature rise in the installation. The cumulative effect of successive overloads can overheat the system.

The thermal memory remembers and integrates the thermal heating caused by each pickup setting overrun.

The thermal memory remembers the thermal heating values for 20 minutes before or after tripping.

Example: Comparison of the heat rise calculation without thermal image (diagram A) and with thermal image (diagram B):

Diagram A

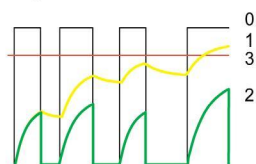
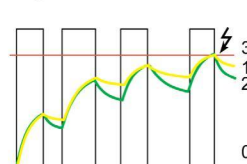

Diagram B



- 0 Load control (cyclical)
- 1 Motor temperature
- 2 Thermal level calculated without thermal image (diagram A), with thermal image (diagram B)
- 3 Overload or thermal protection level

With thermal image, the trip unit adds the thermal effect of successive current pulses. Tripping occurs based on the actual thermal state of the motor.

Cooling Fan

The thermal image of the motor is calculated taking account of the fact that the motor is self-cooled (fan mounted on the shaft end).

Short-Circuit Protection (ANSI 50)

Introduction

Short-circuit protection protects all types of motor applications against very high intensity short-circuit currents.

Operating Principle

Short-circuit protection is fixed: the pickup value is determined by the current rating I_n . Protection is instantaneous.

Tripping curve:

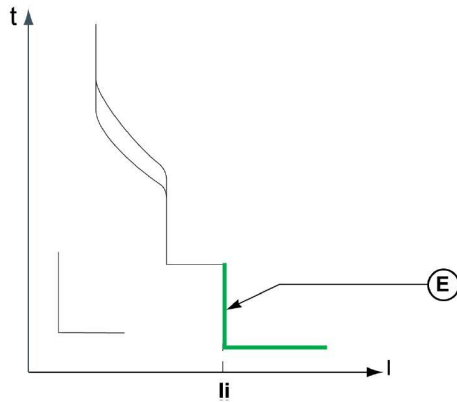

Item	Parameter	Description
E	Ii	Short-circuit protection pickup

Ii Pickup Value

The Ii pickup value is directly determined by the rated current of the device and is equal to $17 \times I_n$. The accuracy range is $\pm 15\%$.

Rating I_n (A)	2	3.5	7	12.5	25	50	80	115
Ii Short-circuit pickup (A)	34	60	119	213	425	850	1,360	1,955

The hold time is 0 ms.

The maximum breaking time is 20 ms.

Section 2.3

Advanced Protections

What Is in This Section?

This section contains the following topics:

Topic	Page
Short-Time Delay Protection (ANSI 51)	32
Ground-Fault Protection (ANSI 51N)	33
Phase Unbalance Protection (ANSI 46)	34
Motor Jam Protection (ANSI 48/51LR)	37
Long-Start Motor Protection (ANSI 48/51LR)	39

Short-Time Delay Protection (ANSI 51)

Introduction

Short-time delay protection protects all types of motor applications against short-circuit currents.

Short-time delay protection lets through motor starting currents but protects cables and motor starter devices and allows not to oversize them (useful for wide range settings circuit breakers).

Operating Principle

Short-time delay protection is definite time. It can be configured as the Isd pickup.

Tripping curve:

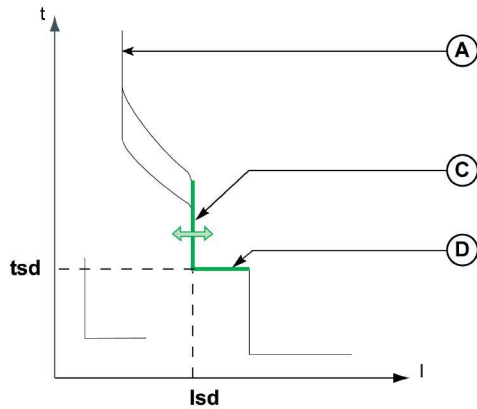

Item	Function	Description
A	Ir	Overload or thermal protection pickup
C	Isd	Short-time delay protection pickup
D	tsd	Short-time delay protection fixed time delay

Setting the Short-Time Delay Protection

Set the Isd pickup:

- With the EcoStruxure Power Device app ([see page 58](#)).
- With the EcoStruxure Power Commission software ([see page 56](#)).

Isd Pickup Setting Value

The Isd pickup setting value is in multiples of Ir.

The default Isd pickup setting value is 13 x Ir (maximum value).

The pickup setting range is 5–13 x Ir. The increment is 0.5 x Ir.

The accuracy range is +/-15%.

tsd Time Delay Value

The time delay cannot be adjusted.

- The hold time is 60 ms.
- The maximum breaking time is 140 ms.

Ground-Fault Protection (ANSI 51N)

Introduction

Ground-fault protection protects all types of motor applications against ground-fault currents in a TN-S system.

Ground-fault protection is activated during startup and in steady state.

Operating Principle

Ground-fault protection is definite time. It can be configured as I_g pickup and as t_g tripping time delay.

Tripping curve:

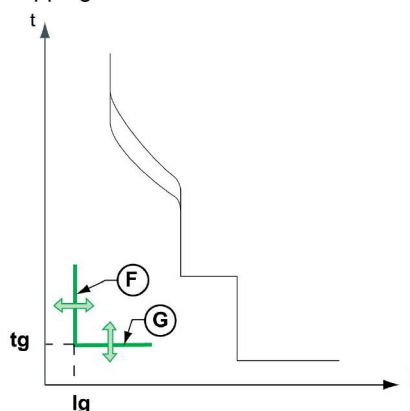

Item	Parameter	Description
F	I_g	Ground-fault protection pickup
G	t_g	Ground-fault protection time delay

Setting the Ground-Fault Protection

Ground-fault protection can be enabled or disabled. The protection is enabled by default.

Set the I_g pickup and t_g time delay:

- With the EcoStruxure Power Device app (*see page 58*).
- With the EcoStruxure Power Commission software (*see page 56*).

I_g Pickup Setting Values

Pickup setting range:

- $0.7-1 \times I_n$ for devices with nominal current from 2 to 50 A
- $0.4-1 \times I_n$ for devices with nominal current from 80 to 115 A

The default I_g pickup setting value is $1 \times I_n$.

The increment is $0.05 \times I_n$.

The accuracy range is $\pm 10\%$.

t_g Time Delay Setting Values

The t_g time delay setting value is in seconds.

The default t_g time delay setting is 0.1 s.

The following table shows t_g setting values in seconds (s) and the associated hold and breaking times in milliseconds (ms):

Function	Value			
t_g (s)	0.1	0.2	0.3	0.4
Hold time (ms)	80	140	230	350
Maximum breaking time (ms)	140	200	320	500

Phase Unbalance Protection (ANSI 46)

Introduction

Phase unbalance protection detects unbalances of the motor phase currents. Phase loss detection is an extreme case of phase unbalance detection.



Unbalances of the motor phase currents lead to significant heat rise and braking torques that can cause premature deterioration of the motor. These effects are amplified during startup; protection must be almost immediate.

Description

Phase unbalance protection:

- Calculates the current unbalance for each phase, compared to the average current, expressed as a percentage:

$$I_{avg} = \frac{(I_1 + I_2 + I_3)}{3}$$

$$I_k \text{ unbalance (\%)} = \frac{I_k - I_{avg}}{I_{avg}} \times 100, \text{ where } k = 1, 2, 3$$

- Compares the value of the maximum current unbalance with the lunbal protection pickup.

The following diagram shows a maximum positive unbalance on phase 2:

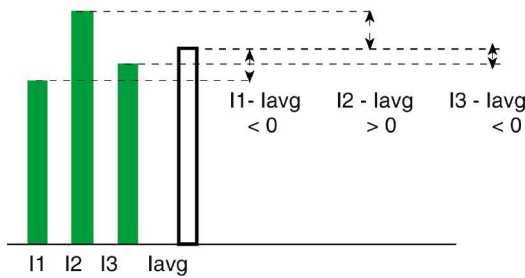

If the maximum current unbalance value is higher than the phase unbalance protection lunbal pickup, the tunbal time delay is actuated.

Phase unbalance protection cannot be deactivated.

Phase unbalance protection is activated during startup and in steady state.

Operating Principle

- The current unbalance does not fall below the lunbal pickup before the end of the tunbal time delay: the phase unbalance protection trips. The behavior of the protection differs according to the motor operating conditions:

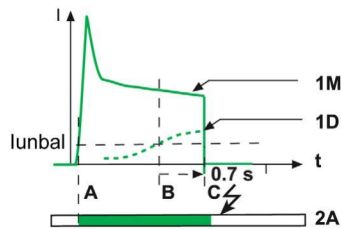

During startup:

- A: Activation of startup phase.
- B: Activation of protection time delay as soon as the pickup is crossed.
- C: Protection tripped at the end of the fixed time delay of 0.7 s.

- 1M Motor current
 1D Maximum unbalance of the motor phase currents
 2A Monitoring by phase unbalance protection during startup
 White: Not active
 Green: Active

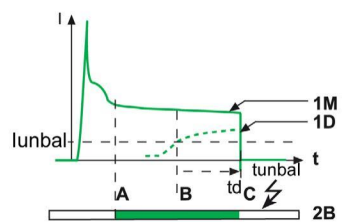

In steady state:

- A: Activation of steady state phase.
- B: Activation of protection time delay as soon as the pickup is crossed.
- C: Protection tripped at the end of the adjustable time delay.

- 1M Motor current
 1D Maximum unbalance of the motor phase currents
 2B Monitoring by phase unbalance protection in steady state
 White: Not active
 Green: Active

- The current unbalance falls below the lunbal pickup before the end of the tunbal time delay: the phase unbalance protection does not trip.

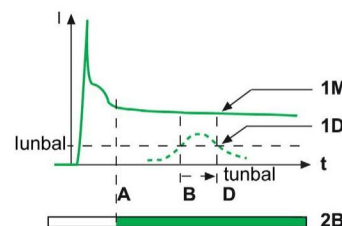

In steady state:

- A: Activation of steady state phase.
- B: Activation of protection time delay as soon as the pickup is crossed.
- D: Time delay is reset.

- 1M Motor current
 1D Maximum unbalance of the motor phase currents
 2B Monitoring by phase unbalance protection in steady state
 White: Not active
 Green: Active

NOTE: The SDx module (set on SDTAM early tripping protection function) can be used to open the contactor instead of tripping the device.

Setting the Protection

Set the lunbal pickup and the tunbal time delay:

- With the EcoStruxure Power Device app ([see page 58](#)).
- With the EcoStruxure Power Commission software ([see page 56](#)).

lunbal Pickup Setting Value

The lunbal pickup setting value is expressed as a percentage of the average current.

The pickup setting range is 10–40%. The increment is 1%. The default pickup setting value is 30%.

The accuracy range is +/-20%.

tunbal Time Delay Setting Value

The tunbal time delay setting value is in seconds.

The tunbal time delay setting depends on the operating conditions:

- During startup, the value of the time delay cannot be adjusted and equals 0.7 s.
- In steady state, the setting range is 1–10 s. The increment is 1 s.

The default time delay setting value is 4 s.

Motor Jam Protection (ANSI 48/51LR)

Introduction

Motor jam protection helps to provide additional protection against:

- Detected over-torque.
- Detected mechanical malfunction.
- Detected malfunctions on machines for which the motor is oversized.

Examples of machines with a significant risk of jamming: conveyors, crushers and kneaders, fans, pumps and compressors.

Description

Motor jam protection compares the value of the average motor current I_{avg} with the setting value of the protection I_{jam} pickup. If the average motor current I_{avg} exceeds the I_{jam} pickup, the protection t_{jam} time delay is actuated.

By default, motor jam protection is not active.

After function setting, motor jam protection is:

- Active in steady state.
- Disabled during startup.

Operating Principle

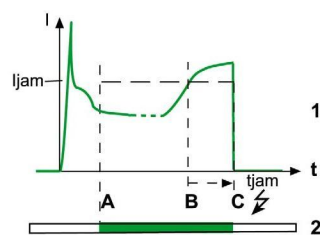

The average motor current I_{avg} does not fall back below the protection I_{jam} pickup before the end of the t_{jam} time delay (jammed motor). Motor jam protection trips:

- A: Protection activated (change to steady state).
- B: Activation of protection time delay as soon as the pickup threshold is crossed.
- C: Protection tripped at the end of the time delay.

- 1 Motor current
- 2 Monitoring by motor jam protection
White: Not active (during startup)
Green: Active (steady state)

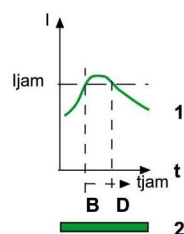

The average motor current I_{avg} falls back and stays below the protection I_{jam} pickup before the end of the t_{jam} time delay (occasional overload). Motor jam protection does not trip:

- B: Activation of protection time delay as soon as the pickup threshold is crossed
- D: Time delay is reset.

- 1 Motor current
- 2 Monitoring by motor jam protection
White: Not active (during startup)
Green: Active (steady state)

NOTE: The SDx module (set on SDTAM early tripping protection function) can be used to open the contactor instead of tripping the device.

Setting the Protection

Motor jam protection can be enabled or disabled. The protection is disabled by default.

Set the I_{jam} pickup and the t_{jam} time delay:

- With the EcoStruxure Power Device app ([see page 58](#)).
- With the EcoStruxure Power Commission software ([see page 56](#)).

Ijam Pickup Setting Value

The Ijam pickup setting value is in multiples of Ir.

The pickup setting range is 1.5–8 x Ir. The increment is 0.1 x Ir. The default pickup setting value is 2 x Ir.

The accuracy range is +/-10%.

tjam Time Delay Setting Value

The tjam time delay setting value is in seconds.

The tjam time delay setting range is 1–30 s. The increment is 1 s. The default time delay setting value is 5 s.

Long-Start Motor Protection (ANSI 48/51LR)

Introduction

Long-start motor protection provides additional protection:

- For machines at risk of difficult starting:
 - High inertia machines
 - High resistive torque machines
 - Machines with fluctuating load from steady state

Examples of machines with a significant risk of difficult starting: fans, compressors.

- To avoid no-load starts:
 - Load not present
 - Machines oversized for the application

Description

Long-start motor protection is activated as soon as the average motor current I_{avg} exceeds 10% of the I_r setting value: the protection t_{long} time delay is actuated. Long-start motor protection compares the value of the average motor current I_{avg} with the setting value of the protection I_{long} pickup.

By default, long-start motor protection is not active.

After function setting, long-start motor protection is:

- Active during startup
- Not active in steady state

Operating Principle (Difficult Starting)

On starting, the average motor current I_{avg} overruns the long-start motor protection I_{long} pickup. The protection remains active as long as the average motor current I_{avg} has not fallen below the I_{long} pickup.

The curve can evolve in one of two ways:

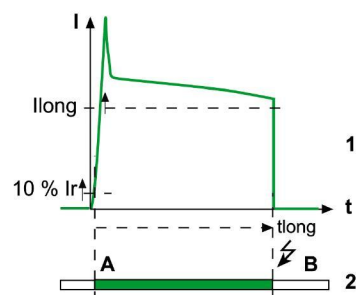

- 1 Motor current
- 2 Activation of long-start motor protection
long time delay
White: Protection not active
Green: Protection active

The average motor current I_{avg} has not fallen below the I_{long} pickup before the end of the t_{long} time delay (starting with a too large load).

Long-start motor protection trips:

- A: Activation of protection time delay (10% of I_r pickup is exceeded).
- B: Protection tripped at the end of the time delay.

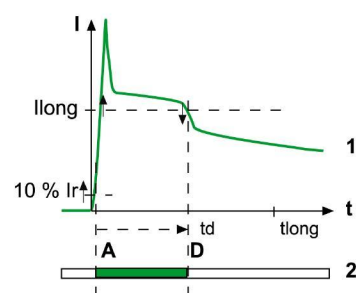

- 1 Motor current
- 2 Activation of long-start motor protection
long time delay
White: Protection not active
Green: Protection active

The average motor current I_{avg} falls below the I_{long} pickup before the end of the t_{long} time delay (correct starting). Long-start motor protection does not trip:

- A: Activation of protection time delay (10% of I_r pickup is exceeded).
- D: Deactivation of protection.

Operating Principle (No-Load Starting)

On starting, the average motor current I_{avg} does not exceed the long-start motor protection I_{long} pickup. The protection remains active as long as the value of the average current I_{avg} has not fallen below 10% of the I_r setting value.

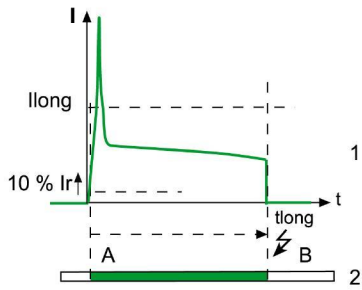

- 1 Motor current
 - 2 Activation of long-start motor protection time delay
- White: Protection not active
Green: Protection active

The motor current has not fallen below 10% of the I_r setting value before the end of the long time delay: long-start motor protection trips.

- A: Activation of protection time delay (10% of I_r pickup is exceeded)
- B: Protection tripped at the end of the time delay

If the motor current falls back below 10% of the I_r setting value before the end of the protection t_{long} time delay (for example on contactor opening), long-start motor protection does not trip.

NOTE: The trip unit filters the subtransient state (first current peak of approximately 20 ms on contactor closing). This current peak is not therefore taken into account when assessing whether the I_{long} pickup has been crossed.

Setting the Protection

Long-start motor protection can be enabled or disabled. The protection is disabled by default.

Set the I_{long} pickup and t_{long} time delay:

- With the EcoStruxure Power Device app ([see page 58](#)).
- With the EcoStruxure Power Commission software ([see page 56](#)).

I_{long} Pickup Setting Value

The pickup setting range is $1.5-8 \times I_r$. The increment is $0.1 \times I_r$. The default pickup setting value is $1.5 \times I_r$. The accuracy range is $\pm 10\%$.

t_{long} Time Delay Setting Value

The t_{long} time delay setting value is in seconds.

The t_{long} time delay setting range is 1–200 s. The increment is 1 s. The default time delay setting value is 10 s.

Chapter 3

Event History

Event History

Overview

All events of trip and alarm detected by the device are logged in the event history.

Event history can be consulted on the EcoStruxure Power Device app.

Events are categorized as trips or alarms:

- A trip is an event generated when the circuit breaker trips.
- An alarm indicates that a threshold is reached.

For a trip, the following information is logged in the event history:

- Name of the trip
- Phase during which trip occurred:
 - Power-up phase
 - Startup state phase
 - Steady state phase

For an alarm, the following information is logged in the event history:

- Name of the alarm
- Counter indicating the number of times the alarm has occurred. It is updated every 15 minutes or after a trip.

Number of Events in Event History

The maximum number of events logged in the history is 16 for the trip and alarms. When the history is full, each new event overwrites the oldest event.

Displaying Event History on EcoStruxure Power Device App

All events logged in the event history are displayed on the EcoStruxure Power Device app through NFC communication. They are displayed in chronological order, with the most recent event displayed at the top of the list.

A pictogram indicates the type of event:

-  Trip
-  Alarm

The event history can be cleared in the EcoStruxure Power Device app (*see page 64*).

List of Trip Events

The following trip events are logged in the event history:

- Ground-fault trip (I_g)
- Overload trip (I_r)
- Short-time delay trip (I_{sd})
- Short-circuit trip (I_i)
- Phase unbalance trip (I_{unb})
- Jam trip (I_{jam})
- Long-start trip (I_{long})

List of Alarm Events

The following alarm events are logged in the event history:

- Overload alarm (T>95%)
- Overload alarm xx s before tripping (T_{xxs})
- Alarm before tripping (TAM)
- Electronic push-to-trip



Chapter 4

Electrical Auxiliary Devices

What Is in This Chapter?

This chapter contains the following topics:

Topic	Page
Electrical Auxiliary Devices	44
Indication Contacts	45
Voltage Releases	47
SDx Module	48

Electrical Auxiliary Devices

Summary of Electrical Auxiliary Devices

The following table shows electrical auxiliary devices that can be added to devices. They can be installed on site. For more information, see the *TeSys Catalogue* (see page 7).

Electrical auxiliary device	Use
OF auxiliary contact	View the on/off status of the device remotely.
SD auxiliary contact	View the trip status of the device remotely.
MN undervoltage release	Trip the device when the control voltage drops below a tripping threshold.
MX shunt trip	Send an electrical trip command remotely.
SDx module	Provide differentiation of detected alarms and detected faults for TeSys GV4PEM / GV4PB devices.

Slots for Electrical Auxiliary Devices

The following figures show the available slots for electrical auxiliary devices mounted in the case of or outside the device. One auxiliary can be installed in each slot, except two for the SDx module.

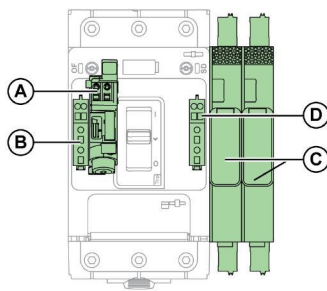

- A MN undervoltage release or MX shunt trip
- B OF auxiliary contact
- C SDx modules (two maximum)
- D SD auxiliary contact

Indication Contacts

Introduction

Use indication contacts to view the status of the device remotely.

The indication contact provides either OF or SD indication functions, depending on its location in the device.

Indication contacts are located under the front face of the device, in a compartment that is isolated from the power circuits. When an indication contact is present, a green flag is displayed on the front of the device.

Description

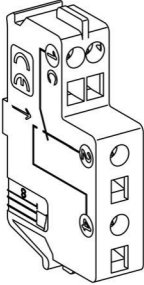
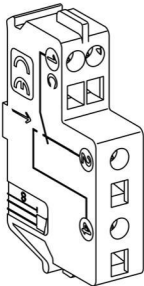
Name	Image	Description
OF open/close indication contact		The OF contact indicates if the device is open or closed.
SD trip indication contact		The SD contact indicates that the device has tripped due to: <ul style="list-style-type: none"> • Operation of the push-to-trip button • Operation of the MN undervoltage release or MX shunt trip • Electrical fault detected by the protection functions

Characteristics

The contacts used for indication contacts are common point changeover contacts.

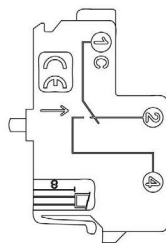



C(1) Common

NC(2) Normally closed contact. The NC contact is normally closed when the device is in the O (OFF) position.

NO(4) Normally open contact. The NO contact is normally open when the device is in the O (OFF) position.

Operation of the Indication Contacts

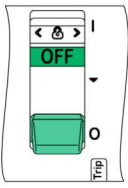
The following figures show the position of the indication contacts for each position of the handle and main contacts.

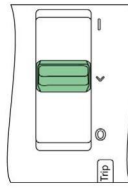
Name	Contact number	Position of the handle and contacts		
Device status	-	OFF	ON	Tripped (by MN/MX, push-to-trip, or electrical fault)
Handle position	-			
Main contact position	-	Open	Closed	Open
OF auxiliary contact position	11-12	Closed	Open	Closed
	11-14	Open	Closed	Open
SD auxiliary contact position	91-92	Closed	Closed	Open
	91-94	Open	Open	Closed

Wiring Diagram

The diagrams are shown with circuits de-energized, all devices open, connected, and charged, and relays in normal position.

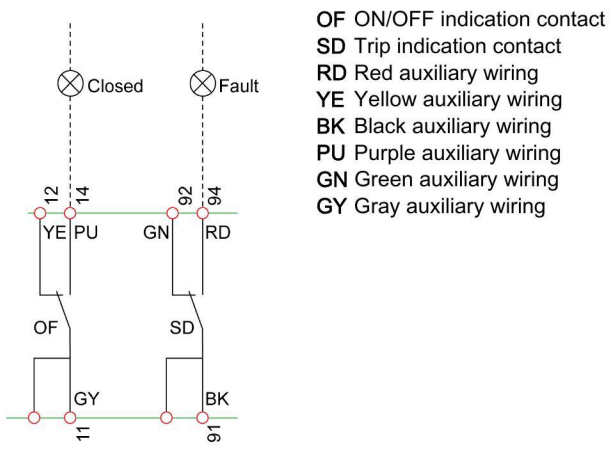

Voltage Releases

Introduction

The following voltage release auxiliaries are operated remotely by an electrical trip command:

- MN undervoltage release
- MX shunt trip

NOTE: It is recommended to test the operation of a voltage release at regular intervals, such as every six months.

Voltage release auxiliaries are installed in the case under the front face of the device. The presence and characteristics of a voltage release auxiliary are displayed through a window on the front face.

Description

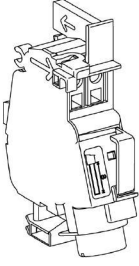
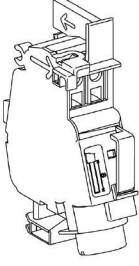
Name	Image	Description
MN undervoltage release		<ul style="list-style-type: none"> • Trips the device when the voltage is less than 0.35 times the rated voltage of the release. ○ If the voltage is between 0.35 and 0.7 times the rated voltage of the release, tripping can occur but is not certain to occur. ○ If the voltage is above 0.7 times the rated voltage of the release, tripping cannot occur. • Allows the device to be closed again when the voltage reaches 0.85 times the rated voltage of the release. <p>Use this type of accessory for emergency stops.</p>
MX shunt trip		<p>Trips the device when the voltage exceeds 0.7 times the rated voltage of the release.</p> <p>NOTE: MX shunt trip 110/130 Vac combined with Class I ground-fault sensing element is suitable for ground-fault protection. In this application, the device trips when the voltage exceeds 0.55 times the rated voltage of the release).</p>

Characteristics

The characteristics of voltage release auxiliaries comply with IEC/EN 60947-2 recommendations.

Wiring Diagram

The diagrams are shown with circuits de-energized, all devices open, connected, and charged, and relays in normal position.

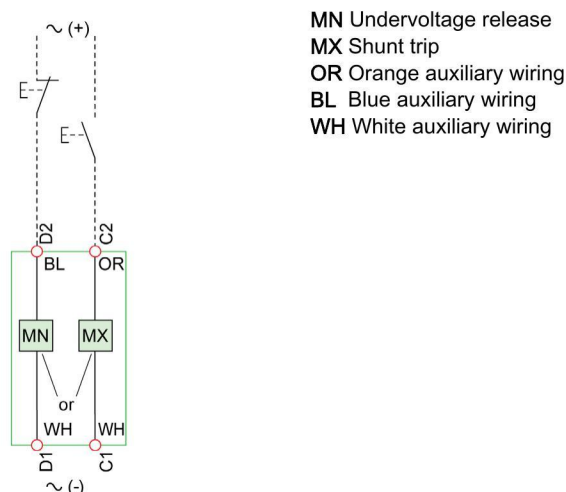

SDx Module

Introduction

One or two optional SDx modules can be installed on the right side of a TeSys GV4PEM / GV4PB device. The SDx module has two outputs and provides differentiation of detected alarms and detected faults. The SDx module receives data from the device through an optical link.

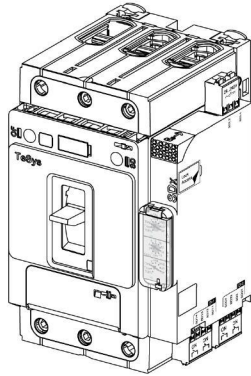

Description

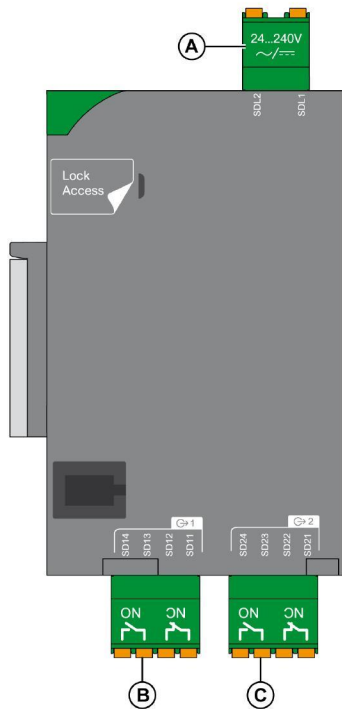

- A Power supply
- B Output 1 (1NO+1NC)
- C Output 2 (1NO+1NC)

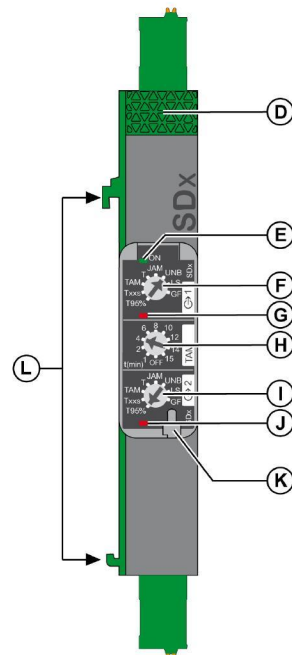

- D Lock knob
- E SDx module status
OFF: SDx module not powered
Green: SDx module powered
- F Output 1 setting dial
- G Output 1 status LED
OFF: output de-activated
Red: output activated
- H SDTAM mode and automatic reset time setting
- I Output 2 setting dial
- J Output 2 status LED
OFF: output de-activated
Red: output activated
- K Seal for setting cover
- L Clips to attach to device

Characteristics

Power supply: 24–240 Vac/Vdc

Output characteristics:

- 2 NO/NC dry contacts
- 24–250 Vac/Vdc
- Minimum load: 2 mA under 24 Vdc
- Max load: 5 A
- AC15 (230 V max - 400 VA)
- DC13 (24 V - 50 W)

The following table shows the contact ratings according to UL/CSA B300 and R300 standards:

Contact rating (per UL/CSA B300 and R300 standards)					
Standard	Rated voltage Ue (V)	Operational current Ie (A)	Make (VA)	Break (VA)	Conventional free-air thermal current Ith (A)
B300	120 Vac	3	3600	360	5
	240 Vac	1.5			
R300	125 Vdc	0.22	28	28	1
	250 Vdc	0.1			

The rated operational current Ie (A), the rated operational voltage Ue (V), and the break apparent power B (VA) are correlated by the formula $B = U_e \times I_e$, with $I_e \leq I_{th}$.

Output Settings

The function assigned to each output of the SDx module is set by using a setting dial. Each output can be assigned with one of the following indications:

- Overload alarm (T95%): The thermal image of the motor is greater than 95% of the permissible temperature rise.
- Overload alarm xx seconds before tripping (Txxs): In the event of a constant load, the device trips in xx seconds.
- Alarm before tripping (TAM): In the event of a phase unbalance, overload, or on a motor jam, this output is activated to open the contactor and avoid device tripping. In this case, contact can be manually or automatically reset after an adjustable cooling time (1–15 minutes). If the motor is not stopped after a 400 ms delay, the device trips.
- Overload trip indication (T): The device has tripped due to an overload.
- Motor jam trip indication (JAM): The device has tripped due to a motor jam.
- Phase unbalance trip indication (UNB): The device has tripped due to a phase unbalance.
- Long-start trip indication (LS): The device has tripped due to a motor long start.
- Ground-fault trip indication (GF): The device has tripped due to a ground fault.

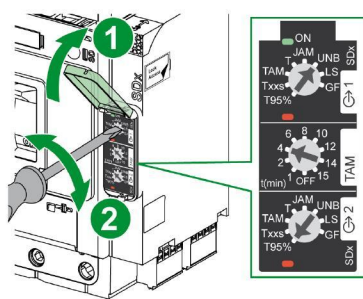

T95%	Overload alarm
Txxs	Overload alarm xx seconds before tripping
TAM	Overload alarm just before tripping
T	Overload trip indication
JAM	Motor jam trip indication
UNB	Phase unbalance trip indication
LS	Long-start trip indication
GF	Ground-fault trip indication

SDT95%, SDTAM, and SDT Operating Modes

Operating modes of the SDT95% output:

- Turn the output setting dial to **T95%**. The output is activated when thermal image of the motor is greater than 95% of the permissible temperature rise.
- The output is reset in the following cases:
 - With the motor running, when the thermal level of the motor is lower than 95% of the permissible temperature rise.
 - Automatically approximately 2 seconds after tripping.
 - When the SDx module power is turned off and on.
 - When the output setting dial position is changed.

Operating modes of the SDTAM output:

- Turn the output setting dial to **TAM**. The output is activated in the event of a phase unbalance, overload, or a motor jam. The device trips if the motor is not stopped within 400 ms after output activation. The manual reset mode or cooling time before automatic reset is set by using the **TAM** multi-position dial in the middle of the front face of the SDx module.
- The output is reset in the following cases:
 - When the **TAM** dial setting is **OFF**, the contact is manually reset by turning the SDx module power off and on.
 - When the **TAM** dial setting is 1–15 minutes, the contact is automatically reset after the cooling time.
 - When the SDx module power is turned off and on.
 - When the output setting dial position is changed.

Operating modes of the SDT output:

- Turn the output setting dial to **T**. The output is activated when the device trips due to an overload.
- The output is reset in the following cases:
 - After tripping, when the device is reset, closed, and the motor is restarted.
 - When the SDx module power is turned off and on.
 - When the output setting dial position is changed.

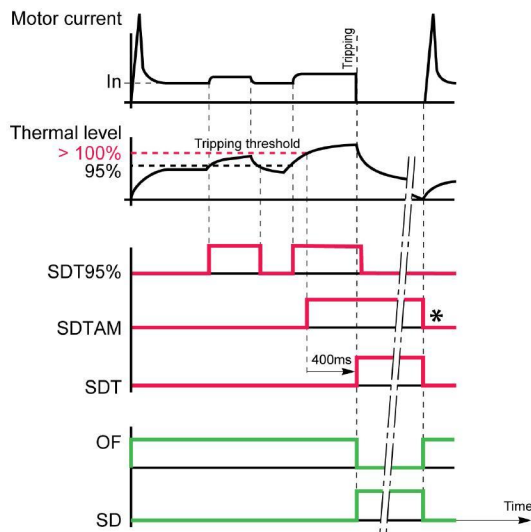

- Curves of TeSys GV4PEM / GV4PB devices
- Curves of SDx modules
- Curves of auxiliary contacts
- SDT95%** 95% overload
- SDTAM** Overload tripping alarm (TAM output contacts not connected to any contactor)
- SDT** Tripping on overload
- *** After automatic reset after cooling time or manual reset on SDX module

SDTxxs Operating Modes

Operating modes of the SDTxxs output:

- Turn the output setting dial to **Txxs**. The output is activated when the device will trip in xx seconds with a constant load.

NOTE:

- If the output is deactivated and the current increases suddenly and results in device tripping in a time shorter than the SDTxxs value, then the output remains deactivated.
- If the output is activated and the current increases strongly and results in device tripping in a time shorter than the SDTxxs value, then the output remains activated.
- If the output is activated and the current decreases and results in device tripping in a time longer than the SDTxxs value, then the output is deactivated.
- xx is adjustable between 10 to 40 seconds (20 seconds is the default value):
 - With the EcoStruxure Power Device app (*see page 58*).
 - With the EcoStruxure Power Commission software (*see page 56*).
- The output is reset in the following cases:
 - With the motor running, when the tripping condition disappears.
 - Automatically approximately 2 seconds after tripping.
 - When the SDx module power is turned off and on.
 - When the output setting dial position is changed.

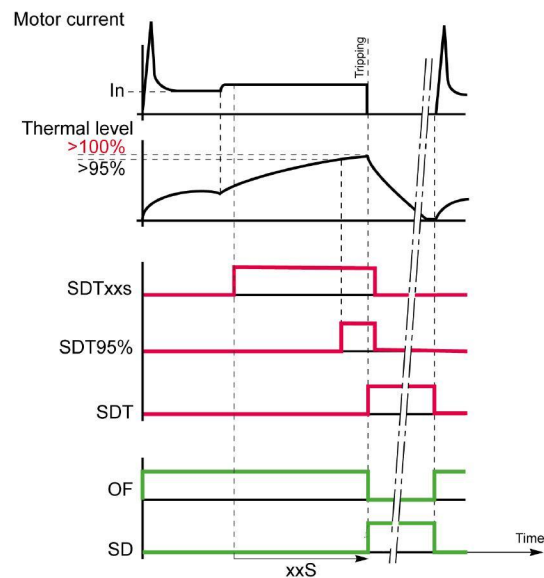

- Curves of TeSys GV4PEM / GV4PB devices
 - Curves of SDx modules
 - Curves of auxiliary contacts
- SDTxxs Overload alarm xx seconds before tripping
 SDT95% 95% overload
 SDT Tripping on overload

SDJAM Operating Modes

Operating modes of the SDJAM output:

- Turn the output setting dial to **JAM**. The output is activated when the device trips due to a motor jam.
- The output is reset in the following cases:
 - After tripping, when the device is reset, closed, and the motor is restarted.
 - When the SDx module power is turned off and on.
 - When the output setting dial position is changed.

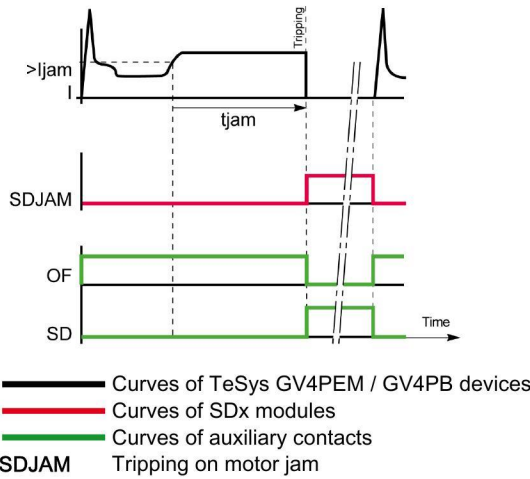

SDUNB Operating Modes

Operating modes of the SDUNB output:

- Turn the output setting dial to **UNB**. The output is activated when the device trips due to a phase unbalance.
- The output is reset in the following cases:
 - After tripping, when the device is reset, closed, and the motor is restarted.
 - When the SDx module power is turned off and on.
 - When the output setting dial position is changed.

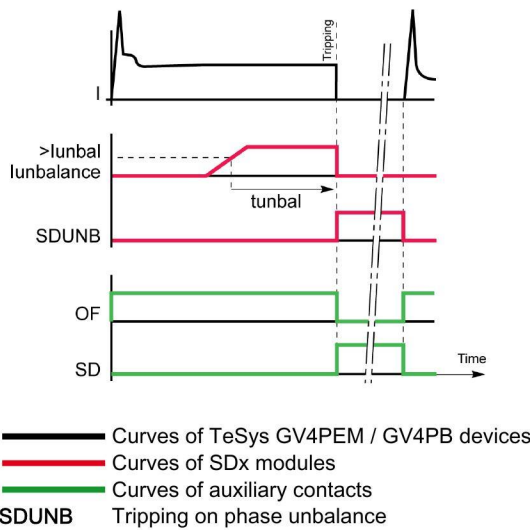

SDLS Operating Modes

Operating modes of the SDLS output:

- Turn the output setting dial to **LS**. The output is activated when the device trips due to a motor long start.
- The output is reset in the following cases:
 - After tripping, when the device is reset, closed, and the motor is restarted.
 - When the SDx module power is turned off and on.
 - When the output setting dial position is changed.

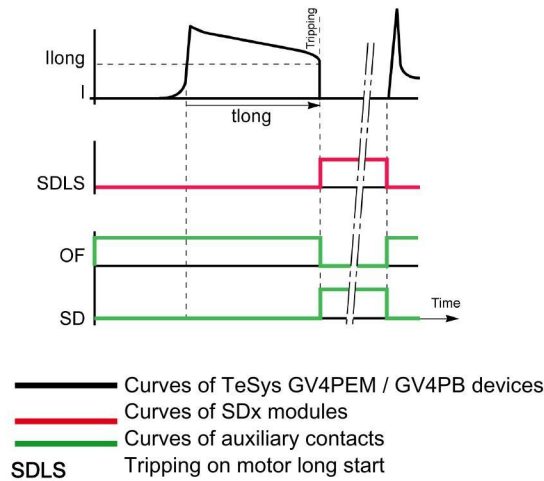

SDGF Operating Modes

Operating modes of the SDGF output:

- Turn the output setting dial to **GF**. The output is activated when the device trips due to a ground fault.
- The output is reset in the following cases:
 - After tripping, when the device is reset, closed, and the motor is restarted.
 - When the SDx module power is turned off and on.
 - When the output setting dial position is changed.

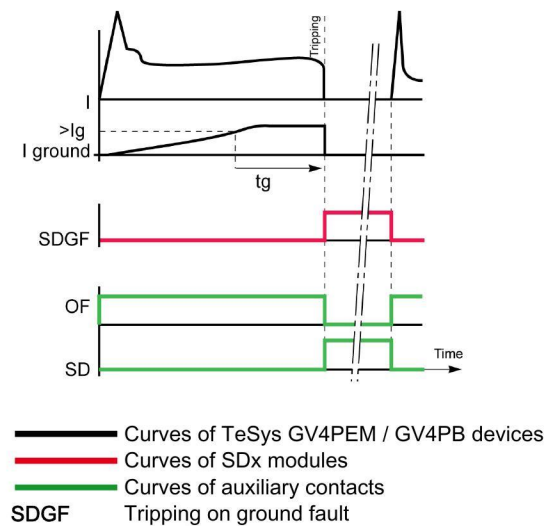

Wiring Diagram

The diagram is shown with circuits de-energized, all devices open, connected, and charged, and relays in normal position.

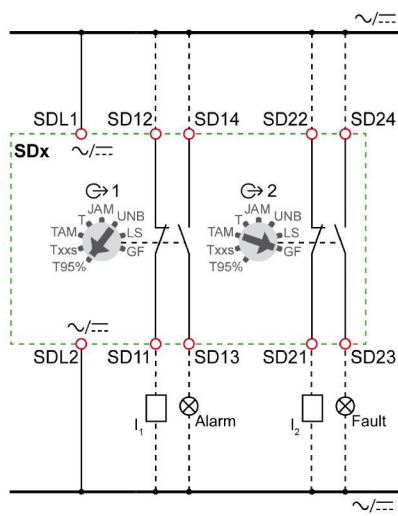

SDx SDx module
 I1, I2 PLC digital inputs (used as alarm inputs, for example)

Chapter 5

Settings

What Is in This Chapter?

This chapter contains the following topics:

Topic	Page
Settings With the EcoStruxure Power Commission Software	56
Settings With the EcoStruxure Power Device App	58

Settings With the EcoStruxure Power Commission Software

Description

Use a PC running the EcoStruxure Power Commission software to access the settings of the protections (except the overload or thermal protection) for TeSys GV4PEM / GV4PB devices. Connect the PC to the maintenance port on the device through the USB maintenance interface.

Prerequisites for Using a USB Connection

The prerequisites for establishing a connection are:

- You must have the USB driver installed on the PC.
- You must have physical access to the device to connect the cable to the maintenance port.

USB Maintenance Interface Kit

The USB maintenance interface kit comprises the following elements:

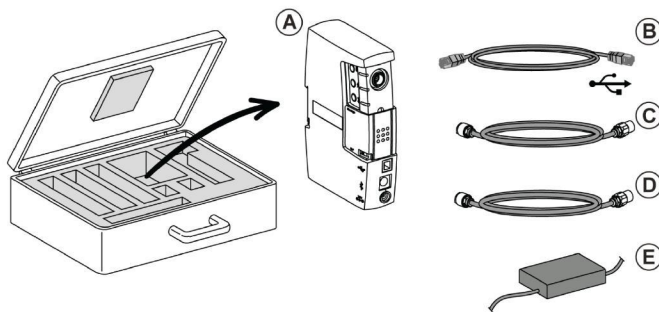

- A USB maintenance interface
- B Standard USB cord for connection to the PC
- C Cord for connecting the USB maintenance interface to the maintenance port on the trip unit
- D Standard RJ45 cord for connecting the USB maintenance interface to a ULP module
- E USB maintenance interface power supply unit

Connecting Through USB Maintenance Interface

The following figure shows the connection of a PC to TeSys GV4PEM / GV4PB devices through the USB maintenance interface.

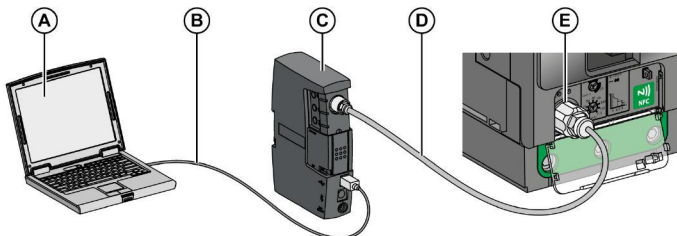

- A PC running the EcoStruxure Power Commission software
- B Standard USB cord
- C USB maintenance interface
- D Cord for USB maintenance interface
- E Maintenance port on TeSys GV4PEM / GV4PB devices

Connecting a PC Running EcoStruxure Power Commission Software to the Device

Follow the steps below to connect a PC to TeSys GV4PEM / GV4PB devices.

Step	Action
1	Connect your PC to the USB maintenance interface by using a standard USB cord.
2	Connect the USB maintenance interface to the maintenance port on the device by using a cord for USB maintenance interface.
3	Start the EcoStruxure Power Commission software on the PC and log in.
4	On the EcoStruxure Power Commission home page, connect to the device. There are different ways to connect the EcoStruxure Power Commission software to the device, depending on whether it is the first connection and how the device is discovered. For more information, refer to <i>EcoStruxure Power Commission Online Help</i> .
5	With the EcoStruxure Power Commission software connected to the device, you have access to all functions of the software.

Settings With the EcoStruxure Power Device App

Description



Using the EcoStruxure Power Device app, you can access the protection settings and download data to your smartphone. The EcoStruxure Power Device app works with an Android smartphone which has Near Field Communication (NFC) capability enabled.

TeSys GV4PEM / GV4PB devices use a passive NFC tag, which does not have a power source. It draws power from the smartphone that reads it, and therefore does not emit any electromagnetic waves when NFC communication is not in use.

NOTE: NFC communication is only accessible from the Android version of the EcoStruxure Power Device app.

A NFC wireless communication zone

Prerequisites for Using NFC on TeSys GV4PEM / GV4PB Devices

The prerequisites for establishing an NFC connection are the following:

- You must have an Android smartphone with the EcoStruxure Power Device app installed.
- The Android smartphone must support NFC functionality.
- You must have physical access to the device.
- Check where the NFC antenna is located on your smartphone. Place and hold the NFC antenna of the smartphone against the NFC wireless communication zone of TeSys GV4PEM / GV4PB devices. To avoid communication loss, do not move your smartphone during communication.
- For TeSys GV4PB devices: the trip unit must be powered by the pocket battery with reference LV434206.

Pocket Battery Description

The pocket battery supplies power to the device during NFC communication. It is mandatory for TeSys GV4PB devices and optional for TeSys GV4PEM devices.

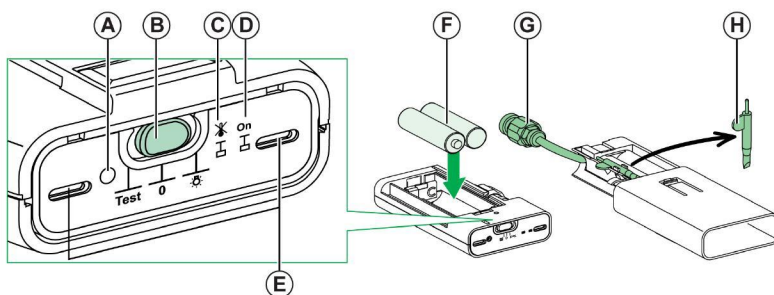

- A Inhibit thermal memory button
- B 3-position slide switch
- C Yellow LED for checking thermal memory inhibition
- D Green LED for checking battery status
- E Two illumination LEDs
- F Two 1.5 V type AA batteries (not supplied)
- G Connector for connecting to the connection port on the trip unit
- H Stylus/screwdriver

Pocket Battery Connection

Follow this procedure to connect the pocket battery to the trip unit by using the cord supplied with the pocket battery:

Step	Action	
1	Switch off the device.	
2	Insert a screwdriver under the clip on the setting cover.	
3	Push the tip of the screwdriver up to release the clip.	
4	Open the setting cover.	
5	Connect the pocket battery cord to the trip unit connection port.	
6	Turn the connector to the right to lock it.	
7	<p>Move the 3-position slide switch to the Test position.</p> <p>Result: The pocket battery supplies power to the trip unit. The LED on the circuit breaker blinks, while the LED on the pocket battery is lit.</p>	

Scanning TeSys GV4PEM / GV4PB Devices

DANGER

HAZARD OF ELECTRIC SHOCK, EXPLOSION, OR ARC FLASH

- While scanning a TeSys GV4PEM / GV4PB device, the phone must be in close proximity to the front of the device.
- Verify there are no exposed live parts that could be contacted during use of this application.
- Make sure that you have a firm grasp on your phone to prevent it from slipping or being dropped.

Failure to follow these instructions will result in death or serious injury.

The following table indicates how to scan TeSys GV4PEM / GV4PB devices.

Step	Action
1	Switch off the device.
2	Activate the NFC functionality of your Android smartphone.
3	Start the EcoStruxure Power Device app on your smartphone.
4	Select the TeSys GV4PEM / GV4PB device you want to connect to. NOTE: At first connection, click the QR image displayed, then scan your device.
5	Click Connect .
6	Read carefully the safety message that displays, then select I UNDERSTAND to confirm.
7	Place the NFC antenna of the smartphone against the NFC wireless communication zone of the device. NOTE: The NFC wireless communication zone of the device is located around the NFC marking on the device (<i>see page 58</i>). The position of the NFC antenna on the smartphone depends on the model of smartphone used. If communication is not established, check where the NFC antenna is located on your smartphone and do the procedure again. Vibrations (and beep if sound activated on the smartphone) indicate that the EcoStruxure Power Device app is downloading data and settings of advanced protection functions. The data download is complete when data is displayed on the smartphone. If the operation is unsuccessful, a message is displayed on the smartphone. Read the message carefully then do the procedure again. NOTE: You must not remove your smartphone from the device while the data download is in progress. If you do, you lose the NFC connection and data is not downloaded.
8	Remove your smartphone from the device. You can use the EcoStruxure Power Device app to consult downloaded data.

Password Management for TeSys GV4PEM / GV4PB Devices

Submitting protection settings from a smartphone to TeSys GV4PEM / GV4PB devices can be protected by password.

Defining a password is:

- Mandatory for TeSys GV4PB
- Optional for TeSys GV4PEM

NOTE: The password is requested if it is not synchronized between the device and the smartphone.

A password is composed of exactly 4 ASCII characters. It is case-sensitive and the allowed characters are:

- Digits from 0 to 9
- Letters from a to z
- Letters from A to Z

Defining a Password for TeSys GV4PEM / GV4PB Devices

A password can be defined with EcoStruxure Power Device app.

The following table indicates how to define a password:

Step	Action
1	Switch off the device.
2	Scan your device (<i>see page 60</i>).
3	Press the information tab  .
4	Press CHANGE PASSWORD .
5	Select Set a password .
6	Enter a password.
7	Confirm your password by entering it again. Result: A success message is displayed. Press OK .
8	Scan your device to submit the password to the device.

Reading, Changing, Saving, and Writing Protection Settings for TeSys GV4PEM Devices



⚠ CAUTION

HAZARD OF UNINTENDED EQUIPMENT OPERATION

- Switch off and lock out the motor before modifying the parameters.
- Apply the modified parameter(s) on TeSys GV4 device.
- Check that all electrical connections are proper and drawers/doors are closed properly before restarting the motor.

Failure to follow these instructions can result in injury or equipment damage.

The following table indicates how to read the protection settings of TeSys GV4PEM device, change, and save them in the EcoStruxure Power Device app, and then submit them to TeSys GV4PEM devices.

Step	Action
1	Switch off the device.
2	Scan your device (see page 60). NOTE: A safety message is displayed on the start-up-screen every two hours. Result: The settings tab  showing available protections and the settings for each protection is displayed.
3	Press the write icon  to change the settings.
4	Select the protection setting you want to change.
5	Change the value of the protection.
6	Select OK to confirm the modification. Result: The changed value is displayed in orange.
7	Repeat step 4 to 6 for each protection setting you want to change.
8	Press the save icon  to save the protection settings for future use, then enter a relevant name for the set of settings and press SAVE . NOTE: A notice appears, indicating that the protection settings have been written successfully in My Settings menu.
9	Select APPLY .
10	A safety message and the existing and new values of the protection settings are displayed. Read carefully the safety message, check the protection settings, and then select UNDERSTOOD AND APPLY .
11	Enter the password if requested, then press OK . For more information, refer to the procedure to manage a password (see page 60).
12	Place the NFC antenna of the smartphone against the NFC wireless communication zone of the device to write the settings to the device.
13	A message is displayed, informing you that: <ul style="list-style-type: none"> ● The settings were written successfully to the device. ● The motor must be restarted. Click OK .
14	Restart the motor or connect the pocket battery to apply the changed protection settings to the device.
15	Scan the device to refresh the settings downloaded.

NOTE: Each new set of settings overwrites the previous settings if the previous settings are not saved.

NOTE: From **My Settings** menu, you can do the following:

- Read a set of protection settings.
- Modify a set of protection settings and save it as a new set.

Reading, Changing, Saving, and Writing Protection Settings for TeSys GV4PB Devices

CAUTION

HAZARD OF UNINTENDED EQUIPMENT OPERATION

- Switch off and lock out the motor before modifying the parameters.
- Apply the modified parameter(s) on TeSys GV4 device.
- Check that all electrical connections are proper and drawers/doors are closed properly before restarting the motor.

Failure to follow these instructions can result in injury or equipment damage.



NOTICE

SETTINGS NOT TAKEN INTO ACCOUNT

Connect the pocket battery (LV434206) to set the advanced protections of the TeSys GV4PB motor circuit breaker.

Failure to follow these instructions can result in the settings not being taken into account.

The following table indicates how to read the protection settings of TeSys GV4PB device, change, and save them in the EcoStruxure Power Device app, and then submit them to TeSys GV4PB devices.

Step	Action
1	Switch off the device.
2	Connect the pocket battery.
3	Scan your device (<i>see page 60</i>). NOTE: A safety message is displayed on the start-up-screen every two hours. Result: The settings tab  showing available protections and the settings for each protection is displayed.
4	Press the write icon  to change the settings.
5	Select the protection setting you want to change.
6	Change the value of the protection.
7	Press OK to confirm the modification. Result: The changed value is displayed in orange.
8	Repeat step 5 to 7 for each protection setting you want to change.
9	Press the save icon  to save the protection settings for future use, then enter a relevant name for the set of settings and press SAVE.
10	Select SUBMIT . Result: A message about connecting the pocket battery appears. Press I UNDERSTAND .
11	Place the NFC antenna of the smartphone against the NFC wireless communication zone of the device to submit the settings to the device. Result: <ul style="list-style-type: none"> • If a success message is displayed, press OK and go to step 13 in the procedure. • If the password is requested, go to step 12 in the procedure.
12	Enter the device password, select OK, and place again the NFC antenna of the smartphone against the NFC wireless communication zone of the device to submit the settings to the device. For more information, refer to the procedure to manage a password (<i>see page 60</i>).
13	Place the NFC antenna of the smartphone against the NFC wireless communication zone of the device to check if the settings were submitted. Result: A success message is displayed. Press OK.
14	A list of settings to modify is displayed. Select APPLY .
15	A safety message and the existing and new values of the protection settings are displayed. Read carefully the safety message, check the protection settings, and then select UNDERSTOOD AND APPLY .
16	Place the NFC antenna of the smartphone against the NFC wireless communication zone of the device to write the settings to the device. Result: A success message is displayed. Press OK.

Step	Action
17	Place the NFC antenna of the smartphone against the NFC wireless communication zone of the device to check if the settings were written to the device. Result: A success message is displayed. Press OK .
18	A list of settings applied to the device appears. Press CLOSE .

NOTE: Each new set of settings overwrites the previous settings if the previous settings are not saved.

NOTE: From **My Settings** menu, you can do the following:

- Read a set of protection settings.
- Modify a set of protection settings and save it as a new set.

Reading and Clearing the Event History for TeSys GV4PEM / GV4PB Devices

Follow the steps below to read and clear the event history in the device.

Step	Action
1	Switch off the device.
2	Scan your device (<i>see page 60</i>).
3	Select the event tab  to display the list of trips and alarms.
4	Select CLEAR ALARMS to clear the event history of the device.
5	Place the NFC antenna of the smartphone against the NFC wireless communication zone of the device. Result: The alarms are cleared from the device and in the app.

Displaying Device Information for TeSys GV4PEM / GV4PB Devices

Follow the steps below to display the information on TeSys GV4PEM / GV4PB devices.

Step	Action
1	Switch off the device.
2	Scan your device (<i>see page 60</i>).
3	Select the information tab  to manage the device password and display the following device information: <ul style="list-style-type: none"> • Serial number • Firmware version • Commercial reference • Data sheet

Troubleshooting NFC Communication Issues for TeSys GV4PEM / GV4PB Devices

The following table lists the common problems that you may encounter while establishing an NFC connection with the device.

Problem description	Probable causes	Solutions
The scan does not start. (No vibration)	The smartphone is out of the NFC wireless communication zone of the device.	Move your smartphone away from the device. Then move your smartphone so that the NFC antenna is in the NFC wireless communication zone and do the scan procedure again.
	Your smartphone has a reinforced case (for example, metallic) which is blocking the signal.	Remove the case of your smartphone and do the scan procedure again.
	Your smartphone does not have NFC capability.	Use another Android smartphone with NFC capability.
	NFC communication is not activated on your smartphone.	Activate NFC communication on your smartphone.
The scan starts (one vibration), but the signal is lost.	The smartphone was moved out of the NFC wireless communication zone of the device before the data transmission finished.	Hold your smartphone away from the device when selecting SCAN MY DEVICE . Then place the antenna of your smartphone against the NFC wireless communication zone of the device and do the scan procedure again. Keep the smartphone in the NFC wireless communication zone until data is displayed on the smartphone.
The data is not transmitted. The message We lost the connection with the device. Please try to place the phone near device NFC area again, till you feel a vibration. is displayed on the smartphone.		
Protection settings were not sent to TeSys GV4PB devices.	The TeSys GV4PB trip unit is not powered by the pocket battery.	Connect the pocket battery.



RSPSupply - 1-888-532-2706 - <https://www.RSPSupply.com>
See the product details here



RSPSupply - 1-888-532-2706 - <https://www.RSPSupply.com>
See the product details here



DOCA0118EN-01

Schneider Electric Industries SAS

35, rue Joseph Monier
CS30323
F - 92506 Rueil Malmaison Cedex

<http://www.schneider-electric.com>

As standards, specifications and designs change from time to time, please ask for confirmation of the information given in this publication.

09/2019